

# Amplifier Transistors

## NPN Silicon

**BC337,-16,-25,-40**  
**BC338,-16,-25,-40**

### MAXIMUM RATINGS

Rating	Symbol	BC337	BC338	Unit
Collector–Emitter Voltage	$V_{CEO}$	45	25	Vdc
Collector–Base Voltage	$V_{CBO}$	50	30	Vdc
Emitter–Base Voltage	$V_{EBO}$	5.0		Vdc
Collector Current — Continuous	$I_C$	800		mAdc
Total Device Dissipation @ $T_A = 25^\circ\text{C}$ Derate above $25^\circ\text{C}$	$P_D$	625	5.0	mW mW/ $^\circ\text{C}$
Total Device Dissipation @ $T_C = 25^\circ\text{C}$ Derate above $25^\circ\text{C}$	$P_D$	1.5	12	Watt mW/ $^\circ\text{C}$
Operating and Storage Junction Temperature Range	$T_J, T_{stg}$	–55 to +150		$^\circ\text{C}$

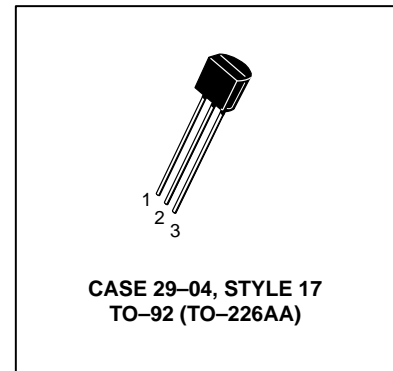

### THERMAL CHARACTERISTICS

Characteristic	Symbol	Max	Unit
Thermal Resistance, Junction to Ambient	$R_{\theta JA}$	200	$^\circ\text{C}/\text{W}$
Thermal Resistance, Junction to Case	$R_{\theta JC}$	83.3	$^\circ\text{C}/\text{W}$

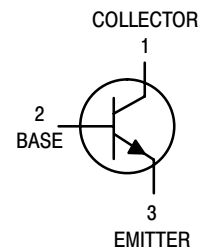

### ELECTRICAL CHARACTERISTICS ( $T_A = 25^\circ\text{C}$ unless otherwise noted)

Characteristic	Symbol	Min	Typ	Max	Unit
----------------	--------	-----	-----	-----	------

### OFF CHARACTERISTICS

Collector–Emitter Breakdown Voltage ( $I_C = 10\text{ mA}, I_B = 0$ )	BC337 BC338	$V_{(BR)CEO}$	45 25	— —	— —	Vdc
Collector–Emitter Breakdown Voltage ( $I_C = 100\ \mu\text{A}, I_E = 0$ )	BC337 BC338	$V_{(BR)CES}$	50 30	— —	— —	Vdc
Emitter–Base Breakdown Voltage ( $I_E = 10\ \mu\text{A}, I_C = 0$ )		$V_{(BR)EBO}$	5.0	—	—	Vdc
Collector Cutoff Current ( $V_{CB} = 30\text{ V}, I_E = 0$ ) ( $V_{CB} = 20\text{ V}, I_E = 0$ )	BC337 BC338	$I_{CBO}$	— —	— —	100 100	nAdc
Collector Cutoff Current ( $V_{CE} = 45\text{ V}, V_{BE} = 0$ ) ( $V_{CE} = 25\text{ V}, V_{BE} = 0$ )	BC337 BC338	$I_{CES}$	— —	— —	100 100	nAdc
Emitter Cutoff Current ( $V_{EB} = 4.0\text{ V}, I_C = 0$ )		$I_{EBO}$	—	—	100	nAdc

# BC337,-16,-25,-40 BC338,-16,-25,-40

## ELECTRICAL CHARACTERISTICS ( $T_A = 25^\circ\text{C}$ unless otherwise noted) (Continued)

Characteristic	Symbol	Min	Typ	Max	Unit
<b>ON CHARACTERISTICS</b>					
DC Current Gain ( $I_C = 100\text{ mA}$ , $V_{CE} = 1.0\text{ V}$ )	BC337/BC338	100	—	630	—
	BC337-16/BC338-16	100	—	250	—
	BC337-25/BC338-25	160	—	400	—
	BC337-40/BC338-40	250	—	630	—
	( $I_C = 300\text{ mA}$ , $V_{CE} = 1.0\text{ V}$ )	60	—	—	—
Base-Emitter On Voltage ( $I_C = 300\text{ mA}$ , $V_{CE} = 1.0\text{ V}$ )	$V_{BE(on)}$	—	—	1.2	Vdc
Collector-Emitter Saturation Voltage ( $I_C = 500\text{ mA}$ , $I_B = 50\text{ mA}$ )	$V_{CE(sat)}$	—	—	0.7	Vdc

## SMALL-SIGNAL CHARACTERISTICS

Output Capacitance ( $V_{CB} = 10\text{ V}$ , $I_E = 0$ , $f = 1.0\text{ MHz}$ )	$C_{ob}$	—	15	—	pF
Current-Gain — Bandwidth Product ( $I_C = 10\text{ mA}$ , $V_{CE} = 5.0\text{ V}$ , $f = 100\text{ MHz}$ )	$f_T$	—	210	—	MHz

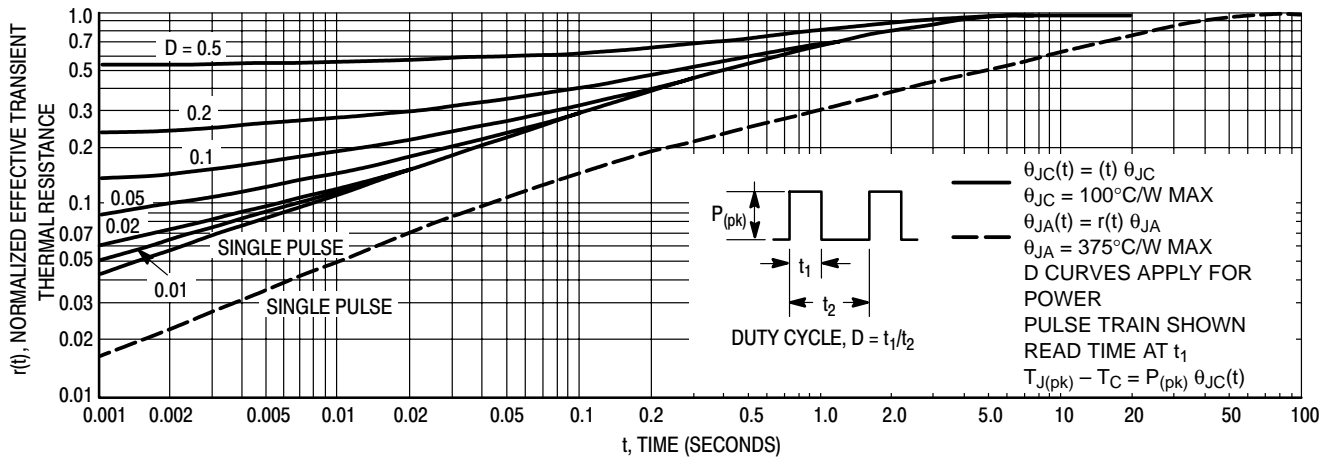

Figure 1. Thermal Response

BC337,-16,-25,-40 BC338,-16,-25,-40

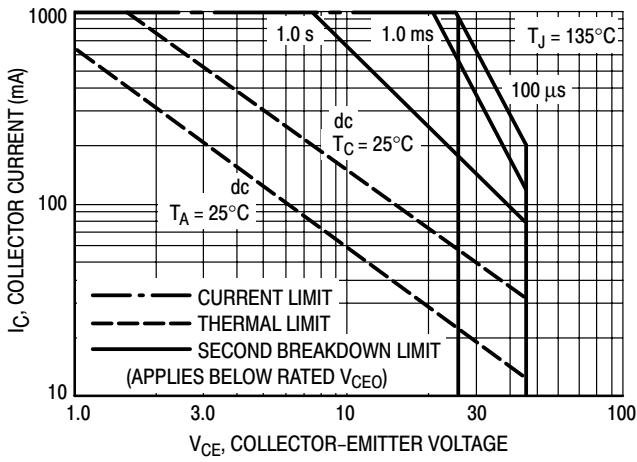

Figure 2. Active Region — Safe Operating Area

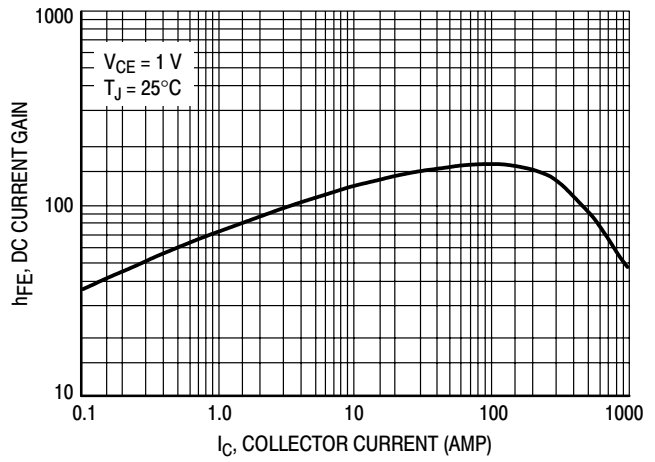

Figure 3. DC Current Gain

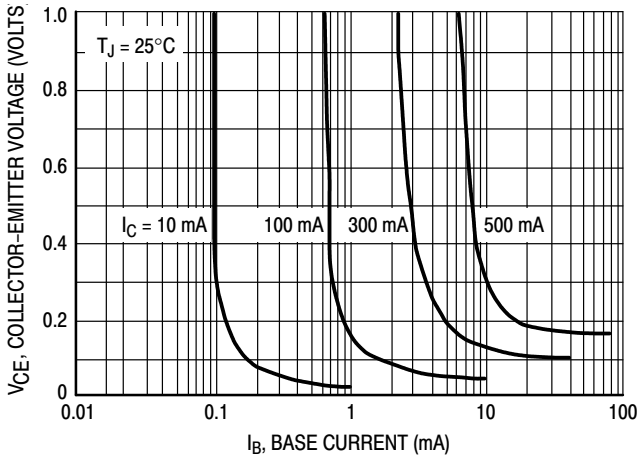

Figure 4. Saturation Region

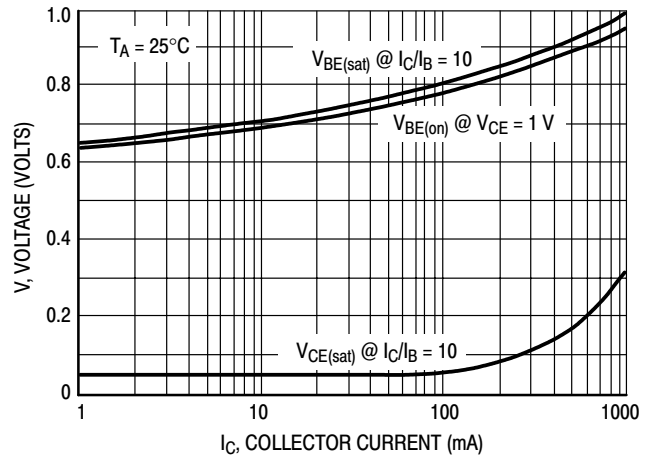

Figure 5. "On" Voltages

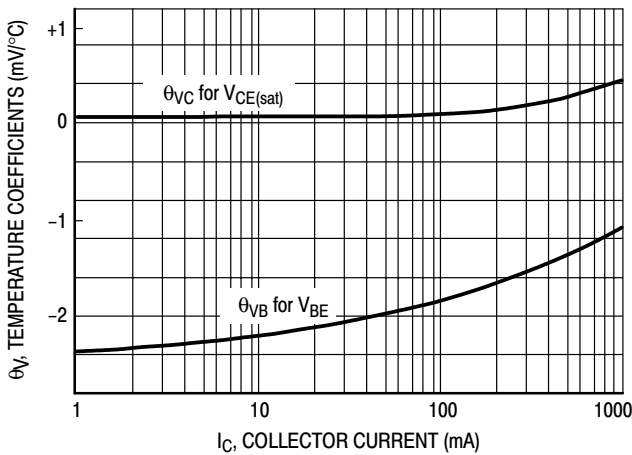

Figure 6. Temperature Coefficients

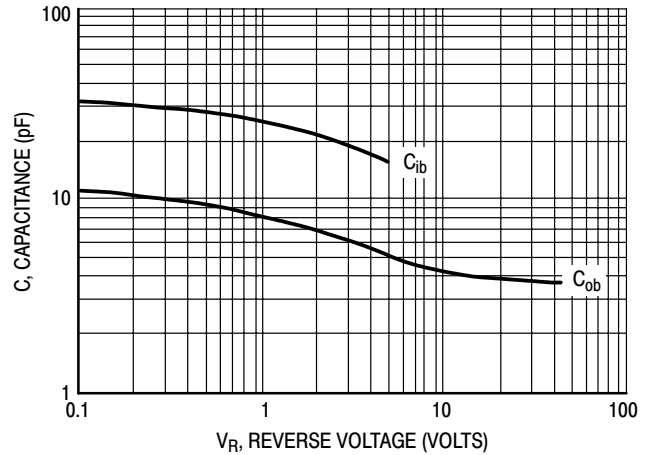
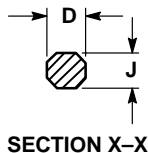
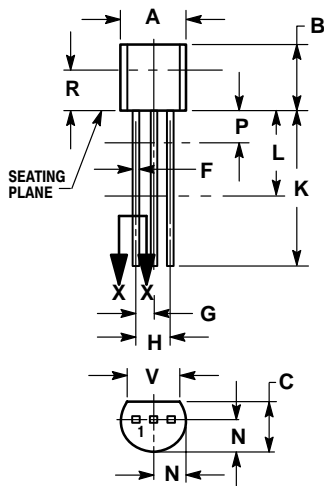

Figure 7. Capacitances

# BC337,-16,-25,-40 BC338,-16,-25,-40

## PACKAGE DIMENSIONS

### CASE 029-04 (TO-226AA) ISSUE AD



STYLE 17:  
PIN 1. COLLECTOR  
2. BASE  
3. EMITTER

#### NOTES:

1. DIMENSIONING AND TOLERANCING PER ANSI Y14.5M, 1982.
2. CONTROLLING DIMENSION: INCH.
3. CONTOUR OF PACKAGE BEYOND DIMENSION R IS UNCONTROLLED.
4. DIMENSION F APPLIES BETWEEN P AND L. DIMENSION D AND J APPLY BETWEEN L AND K. MINIMUM LEAD DIMENSION IS UNCONTROLLED IN P AND BEYOND DIMENSION K MINIMUM.

DIM	INCHES		MILLIMETERS	
	MIN	MAX	MIN	MAX
A	0.175	0.205	4.45	5.20
B	0.170	0.210	4.32	5.33
C	0.125	0.165	3.18	4.19
D	0.016	0.022	0.41	0.55
F	0.016	0.019	0.41	0.48
G	0.045	0.055	1.15	1.39
H	0.095	0.105	2.42	2.66
J	0.015	0.020	0.39	0.50
K	0.500	---	12.70	---
L	0.250	---	6.35	---
N	0.080	0.105	2.04	2.66
P	---	0.100	---	2.54
R	0.115	---	2.93	---
V	0.135	---	3.43	---

**ON Semiconductor** and  are trademarks of Semiconductor Components Industries, LLC (SCILLC). SCILLC reserves the right to make changes without further notice to any products herein. SCILLC makes no warranty, representation or guarantee regarding the suitability of its products for any particular purpose, nor does SCILLC assume any liability arising out of the application or use of any product or circuit, and specifically disclaims any and all liability, including without limitation special, consequential or incidental damages. "Typical" parameters which may be provided in SCILLC data sheets and/or specifications can and do vary in different applications and actual performance may vary over time. All operating parameters, including "Typicals" must be validated for each customer application by customer's technical experts. SCILLC does not convey any license under its patent rights nor the rights of others. SCILLC products are not designed, intended, or authorized for use as components in systems intended for surgical implant into the body, or other applications intended to support or sustain life, or for any other application in which the failure of the SCILLC product could create a situation where personal injury or death may occur. Should Buyer purchase or use SCILLC products for any such unintended or unauthorized application, Buyer shall indemnify and hold SCILLC and its officers, employees, subsidiaries, affiliates, and distributors harmless against all claims, costs, damages, and expenses, and reasonable attorney fees arising out of, directly or indirectly, any claim of personal injury or death associated with such unintended or unauthorized use, even if such claim alleges that SCILLC was negligent regarding the design or manufacture of the part. SCILLC is an Equal Opportunity/Affirmative Action Employer.

## PUBLICATION ORDERING INFORMATION

### NORTH AMERICA Literature Fulfillment:

Literature Distribution Center for ON Semiconductor  
P.O. Box 5163, Denver, Colorado 80217 USA  
**Phone:** 303-675-2175 or 800-344-3860 Toll Free USA/Canada  
**Fax:** 303-675-2176 or 800-344-3867 Toll Free USA/Canada  
**Email:** ONlit@hibbertco.com  
Fax Response Line: 303-675-2167 or 800-344-3810 Toll Free USA/Canada

### N. American Technical Support: 800-282-9855 Toll Free USA/Canada

### EUROPE: LDC for ON Semiconductor – European Support

**German Phone:** (+1) 303-308-7140 (Mon-Fri 2:30pm to 7:00pm CET)  
**Email:** ONlit-german@hibbertco.com  
**French Phone:** (+1) 303-308-7141 (Mon-Fri 2:00pm to 7:00pm CET)  
**Email:** ONlit-french@hibbertco.com  
**English Phone:** (+1) 303-308-7142 (Mon-Fri 12:00pm to 5:00pm GMT)  
**Email:** ONlit@hibbertco.com

### EUROPEAN TOLL-FREE ACCESS\*: 00-800-4422-3781

\*Available from Germany, France, Italy, UK, Ireland

### CENTRAL/SOUTH AMERICA:

**Spanish Phone:** 303-308-7143 (Mon-Fri 8:00am to 5:00pm MST)  
**Email:** ONlit-spanish@hibbertco.com  
**Toll-Free from Mexico:** Dial 01-800-288-2872 for Access –  
then Dial 866-297-9322

### ASIA/PACIFIC: LDC for ON Semiconductor – Asia Support

**Phone:** 303-675-2121 (Tue-Fri 9:00am to 1:00pm, Hong Kong Time)  
**Toll Free from Hong Kong & Singapore:**  
**001-800-4422-3781**  
**Email:** ONlit-asia@hibbertco.com

### JAPAN: ON Semiconductor, Japan Customer Focus Center

4-32-1 Nishi-Gotanda, Shinagawa-ku, Tokyo, Japan 141-0031  
**Phone:** 81-3-5740-2700  
**Email:** r14525@onsemi.com

### ON Semiconductor Website: <http://onsemi.com>

For additional information, please contact your local Sales Representative.